



Range of cylindrical cased axial flow fans fitted with aluminium impellers and manufactured from high grade rolled galvanised steel and protected against corrosion by cataforesis primer and black polyester paint finish. All models are supplied with pre-wired wiring junction box located on the outside of the fan casing for easy wiring access. Available, depending upon the model, with single or three phase motors in 2, 4 or 6 poles.

Motors

Single phase motor (TCBB) or three phase motor (TCBT).
 Models 250, 315, 355 and 400: External rotor motor, IP54, Class F, thermal protection, working temperature from -40°C to +40°C.
 Models 450, 500, 560, 630 and 6/710: IP65, Class F, thermal protection, working temperature from -40°C to +70°C.
 Models 4/710 and 800: IP55, Class F, working temperature from -40°C to +40°C.

All motors are speed controllable by autotransformer except models /4-560H, /4-630, 710 and T/800.
 Three phase motors are speed controllable by inverter.
 Electrical supplies:
 Single phase 220-240V-50Hz.
 [Capacitor located inside the wiring terminal box].
 Three phase 220-240/380-415V-50Hz or 380-415V-50Hz.
 [See characteristic chart].

Additional information

Standard air direction: form (B) configuration (impeller over motor).

On request

Air direction: form (A) configuration (motor over impeller).
 From Ø450 to Ø800, three phase motors 2 speed, 4/8 poles.

ATEX versions TCBT

On request, explosion proof versions in accordance with ATEX Directive, for 3 phase models.

For ambient working temperatures:

- From -20°C to +55°C: models TCBT/4-315 to 630mm models TCBT/6-355 to 710mm
- From -20°C to +40°C: models TCBT/4-710 to 800mm models TCBT/6-800mm

Motors IP55 Class F

- ATEX Flameproof - Gas

In standard ATEX version flameproof motors are without thermal protection.

If used with frequency inverter, flameproof motors with a PTC-type thermal protection must be specified at order.

For models TCBT/4-710 and 800mm

- ⊕ models 2G Exd IIB T4
- ⊕ models 2G Exd IIB(H2) T4 (with Ex d IIC T4 motor)

- ATEX Increased safety - Gas

- Not available TCBT/2-250/H 400V-50Hz
- TCBT/4-250/H 400V-50Hz
- TCBT/6-355/H 400V-50Hz
- TCBT/6-400/H 400V-50Hz

Available for TCBT/6-400/H 230/400V-50Hz and larger sizes.

- ⊕ models 2G Exe II T3

- ATEX - Dust

In standard ATEX version, ATEX motors for dust are without thermal protection. If used with frequency inverter, ATEX motors for dust with a PTC-type thermal protection must be specified at order.



Corrosion resistance

Rolled steel casings and motor support protected by cataforesis primer and black polyester paint finish. Stainless steel screws.



Terminal box

Wiring terminal box with cable gland PG-11 (except ATEX models).



Impeller dynamically balanced

Impellers are dynamically balanced, according to ISO 1940 standard, giving vibration free operation.



Configuration for models /4-710 and 800.



Constructive configuration models 250, 315, 355 and 400 (excepted 6-355, 6-400 and ATEX)

- For models TCBT/4-710 and 800mm
- Suspended flammable particles and non-conductive dust:
- ⊕ II 3D Ex tc IIB T125°C
- Conductive dust:
- ⊕ II 3D Ex tc IIIC T125°C (with IP65 motor)

To select TCBT ATEX refer to performance curves, or Easyvent.
 Note electrical data may vary for ATEX motors.

Specific applications



Versions

CYLINDRICAL CASED AXIAL FLOW FANS COMPACT TCBB / TCBT Series - ALUMINIUM IMPELLERS



TECHNICAL CHARACTERISTICS

Before installation check that the product electrical characteristics listed on the data plate label (voltage, power, frequency, etc.) match those of the intended electrical supply.

Model	Speed (r.p.m.)	Diameter (mm)	Maximum absorbed power (W)	Maximum current (A)		Sound pressure level* (dB(A))	Maximum airflow (m ³ /h)	Weight (kg)	Speed controller		Variable frequency inverter	
				a 230 V	a 400 V				REB	RMB/T	VFTM	VFKB
SINGLE PHASE 2 POLE												
TCBB/2-250/H	2680	250	123	0,5	-	62	1.680	8	-	-	-	-
SINGLE PHASE 4 POLE												
TCBB/4-250/H	1430	250	44	0,2	-	42	900	8	REB-1	RMB-1,5	-	-
TCBB/4-315/H	1435	315	105	0,6	-	52	1.990	11	REB-1	RMB-1,5	-	-
TCBB/4-355/H	1420	355	120	0,6	-	52	2.460	13,2	REB-2,5	RMB-1,5	-	-
TCBB/4-400/H	1410	400	277	1,1	-	60	5.050	15,5	REB-2,5	RMB-3,5	-	-
TCBB/4-450/H	1410	450	591	2,5	-	63	6.940	21	-	-	-	-
TCBB/4-500/H	1410	500	636	2,8	-	66	7.500	25	REB-5	RMB-3,5	-	-
TCBB/4-560/L	1405	560	1289	6	-	68	11.990	33	REB-10	RMB-8	-	-
TCBB/4-560/H	1400	560	1308	6	-	69	12.170	34,7	-	-	-	-
TCBB/4-630/L	1365	630	1707	7,5	-	70	15.980	40	-	-	-	-
SINGLE PHASE 6 POLE												
TCBB/6-355/H	880	355	92	0,4	-	46	2.160	13,2	REB-1	RMB-1,5	-	-
TCBB/6-400/H	870	400	118	0,5	-	48	2.820	15,5	REB-1	RMB-1,5	-	-
TCBB/6-500/H	920	500	226	1	-	57	5.250	24,8	REB-2,5	RMB-1,5	-	-
TCBB/6-560/L	930	560	375	1,6	-	60	7.810	33,5	REB-5	RMB-3,5	-	-
TCBB/6-630/L	920	630	514	2,1	-	60	10.410	38,5	REB-5	RMB-8	-	-
TCBB/6-710/L	930	710	849	4,2	-	62	14.480	46	-	-	-	-
THREE PHASE 2 POLE												
TCBT/2-250/H	2775	250	114	0,3	0,2	62	1.730	8	-	-	TRI-0,37	VFKB-45
THREE PHASE 4 POLE												
TCBT/4-250/H	1470	250	42	0,3	0,2	42	900	8	-	RMT-1,5	TRI-0,37	VFKB-45
TCBT/4-315/H	1445	315	99	0,5	0,3	51	1.950	11	-	RMT-1,5	TRI-0,37	VFKB-45
TCBT/4-355/H	1415	355	117	0,5	0,3	52	2.470	13,2	-	RMT-1,5	TRI-0,37	VFKB-45
TCBT/4-400/H	1410	400	268	0,9	0,5	60	4.950	15,5	-	RMT-1,5	TRI-0,37	VFKB-45
TCBT/4-450/H	1405	450	526	1,9	1,1	63	6.650	21	-	RMT-2,5	TRI-0,55	VFKB-45
TCBT/4-500/H	1420	500	641	2,6	1,5	66	7.590	25	-	RMT-2,5	TRI-0,55	VFKB-45
TCBT/4-560/L	1415	560	1184	3,8	2,2	68	12.090	33	-	RMT-2,5	TRI-0,75	VFKB-45
TCBT/4-560/H	1390	560	1348	4,2	2,4	69	13.370	34,7	-	-	TRI-1,1	VFKB-45
TCBT/4-630/L	1410	630	1768	5,9	3,4	70	16.370	39	-	-	TRI-1,5	VFKB-45
TCBT/4-630/H	1400	630	1940	6,2	3,6	70	17.030	40	-	-	TRI-1,5	VFKB-45
TCBT/4-710/L	1435	710	2175	6,4	3,7	73	20.290	46	-	-	TRI-1,5	VFKB-45
TCBT/4-710/H	1460	710	3441	10,6	6,1	73	26.420	54	-	-	TRI-3	VFKB-48
TCBT/4-800/L	1460	800	3750	11,3	6,5	76	29.950	65	-	-	TRI-3	VFKB-48
TCBT/4-800/K	1460	800	5177	-	8,8	76	34.950	68	-	-	TRI-4	-
TCBT/4-800/G	1470	800	6146	-	11,1	77	38.500	81	-	-	TRI-5,5	-
TCBT/4-800/H	1475	800	7688	-	13	78	42.490	89	-	-	TRI-5,5	-
THREE PHASE 6 POLE												
TCBT/6-355/H	900	355	97	0,4	0,2	47	2.250	13,2	-	RMT-1,5	TRI-0,37	VFKB-45
TCBT/6-400/H	860	400	116	0,4	0,2	49	2.970	15,5	-	RMT-1,5	TRI-0,37	VFKB-45
TCBT/6-450/H	940	450	161	0,7	0,4	54	4.020	20,7	-	RMT-1,5	TRI-0,37	VFKB-45
TCBT/6-500/H	930	500	198	0,9	0,5	57	4.990	24,8	-	RMT-1,5	TRI-0,37	VFKB-45
TCBT/6-560/H	920	560	363	1,4	0,8	60	7.630	33,5	-	RMT-2,5	TRI-0,55	VFKB-45
TCBT/6-630/L	915	630	595	-	1,3	60	10.940	38	-	RMT-2,5	TRI-0,55	VFKB-45
TCBT/6-630/H	950	630	906	-	2,7	62	13.610	38,5	-	RMT-5	TRI-1,1	VFKB-45
TCBT/6-710/L	910	710	967	3,5	2,0	62	16.240	46	-	-	TRI-1,1	VFKB-45
TCBT/6-710/H	910	710	1378	5,4	3,1	63	19.120	46	-	-	TRI-1,1	VFKB-45
TCBT/6-800/L	965	800	1278	4,7	2,7	66	20.770	57	-	-	TRI-1,1	VFKB-45
TCBT/6-800/K	975	800	1592	5,7	3,3	66	24.090	64	-	-	TRI-1,5	VFKB-45
TCBT/6-800/G	975	800	1968	8,0	4,6	67	26.310	68	-	-	TRI-2,2	VFKB-45
TCBT/6-800/H	970	800	2345	8,7	5	68	27.910	80	-	-	TRI-2,2	VFKB 48

* Sound pressure level measured in free field conditions at a distance equivalent to three times the diameter of the impeller with a minimum of 1,5 meters.
For more information see Acoustic characteristics.

REFERENCE

T	C	B	T	/	4	-	4	0	0	/	H	-	B	4	0	0	V	5	0	Hz				
1	2	3	4		5		6				7		8						9		10			11

- 1 - **T**: Cylindrical cased axial flow fan.
- 2 - **C**: Series designation.
- 3 - Impeller type:
B: Ø 250 - Ø 400 Fixed blade impeller manufactured from aluminium sheet.
Ø 450 - Ø 800 Adjustable blade aluminium impeller.
- 4 - Supply type:
B: Single phase.
T: Three phase.
- 5 - Number of poles:
2: [approx. 2800 rpm - 50 Hz]
4: [approx. 1400 rpm - 50 Hz]
6: [approx. 900 rpm - 50 Hz]
- 6 - Nominal diameter of fan in mm. Ø 450 up to Ø 800 mm.
- 7 - Pitch angle. 6/12 poles of motor for models from Ø 710 up to Ø 800 mm.
- 8 - Direction of air:
A: Motor over Impeller.
B: Impeller over Motor.
- 9 - Voltage:
230 V (single phase).
230/400 V (three phase).
400 V (three phase).
- 10 - Frequency of service: 50 Hz
60 Hz
- 11 - Special versions:
2 V: Two speed motors.
4/8 poles of motor for models:

C: Condensation drain holes on motor.
EX: Explosion proof and flame proof versions.

SUPPLY VOLTAGES AND FREQUENCIES



Mains supply voltage	Motor type	Connection	Speed
SINGLE PHASE 220V-50Hz, 240V-50Hz	230V 50Hz	See wiring diagram	High
THREE PHASE 220V-50Hz 240V-50Hz	230/400V 50Hz		High
			Low*
THREE PHASE 380V-50Hz 415V-50Hz	230/400V 50Hz		High
			High
			Low*

* For models allowed by speed controller RMT.

ACOUSTIC CHARACTERISTICS

The sound levels shown in the technical characteristic chart and performance curves, correspond to the value of sound pressure dB(A), measured in free field conditions at a distance equivalent to three times the diameter of the impeller with a minimum of 1.5 meters.

Sound power level spectrum in dB(A) at the corresponding frequency band in Hz and the point of maximum flow.

Model	63	125	250	500	1000	2000	4000	8000	LwA
/2-250/H	31	44	59	65	74	70	64	56	76

Model	63	125	250	500	1000	2000	4000	8000	LwA
/4-250/H	24	37	41	47	52	52	47	41	57
/4-315/H	40	51	45	53	59	59	51	43	63
/4-355/H	24	40	45	55	58	58	49	42	62
/4-400/H	46	53	59	66	69	69	66	58	74
/4-450/H	46	58	65	71	73	71	67	59	77
/4-500/H	50	62	69	75	76	75	70	62	81
/4-560/L	52	64	71	77	78	77	72	64	83
/4-560/H	53	65	72	78	79	78	73	65	84
/4-630/L	56	67	75	80	82	81	76	68	87
/4-630/H	56	67	75	80	82	81	76	68	87
/4-710/L	53	69	79	85	86	84	78	70	91
/4-710/H	60	72	79	85	86	85	80	72	91
/4-800/L	57	73	83	90	91	88	82	74	95
/4-800/K	63	75	82	88	90	88	84	76	94
/4-800/G	64	76	83	89	90	89	84	76	95
/4-800/H	66	77	84	90	92	91	86	78	96

Model	63	125	250	500	1000	2000	4000	8000	LwA
/6-355/H	31	42	49	55	57	55	51	43	61
/6-400/H	33	44	51	57	59	58	53	45	64
/6-450/H	40	51	58	63	64	62	56	48	69
/6-500/H	43	53	61	66	66	64	58	50	71
/6-560/L	46	57	64	69	70	67	61	53	74
/6-560/H	46	56	64	69	69	67	61	53	74
/6-630/L	49	59	66	71	72	70	64	56	77
/6-630/H	51	61	68	73	74	72	66	58	79
/6-710/L	52	62	69	75	75	73	67	59	80
/6-710/H	53	64	71	76	77	75	69	61	82
/6-800/L	51	66	76	79	79	76	69	61	84
/6-800/K	51	66	76	79	79	76	69	61	84
/6-800/G	56	67	74	79	80	78	72	64	85
/6-800/H	58	69	76	81	82	79	73	65	86

CYLINDRICAL CASED AXIAL FLOW FANS COMPACT TCBB / TCBT Series - ALUMINIUM IMPELLERS



DIMENSIONS (mm)

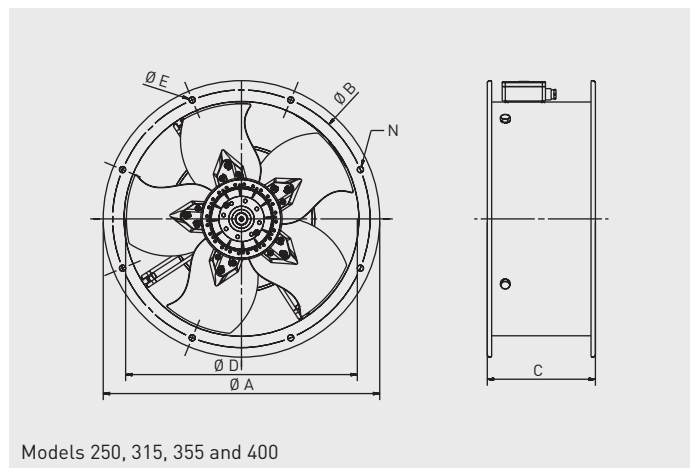

Models 250, 315, 355 and 400

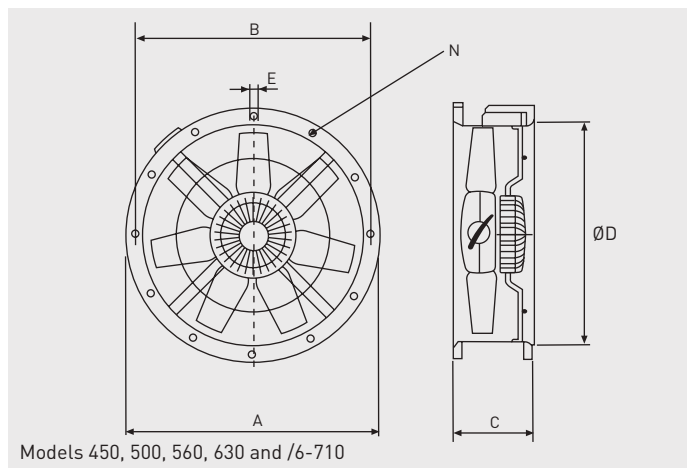

Models 450, 500, 560, 630 and /6-710

Model	Ø A	Ø B	C	Ø D	Ø E	Number of holes N
250	327	292	170	254	10	4
315	386	355	170	315	10	8
355	426	395	170	355	10	8
400 (6 poles)	487	450	170	400	12	8
400 (4 poles)	487	450	210	400	12	8
450	537	500	180	450	12	8
500	595	560	180	500	12	12
560	655	620	240	560	12	12
630	725	690	240	630	12	12
710 (6 poles)	806	770	240	710	12	16

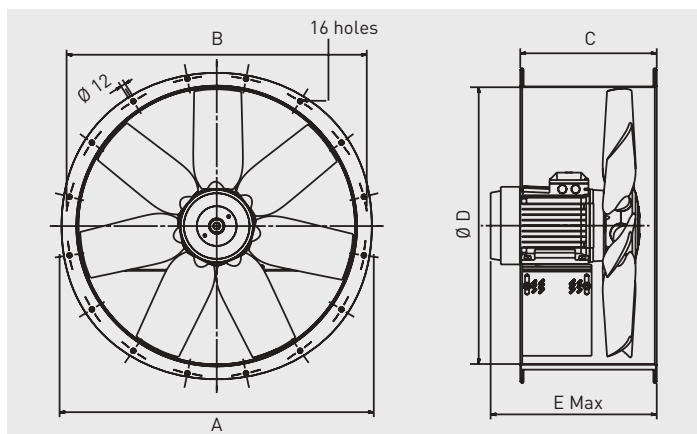

Model	Ø A	B	C	Ø D	E		
					4 poles	6 poles	8 poles
710/L (4 poles)	806	770	380	710	415	-	-
710/H (4 poles)	806	770	380	710	444	-	-
800/L	896	860	380	800	437	408	383
800/K	896	860	380	800	448	437	408
800/G	896	860	380	800	447 (5,5kW)	515 (7,5kW)	448
800/H	896	860	380	800	515	477	437

MOUNTING ACCESSORIES

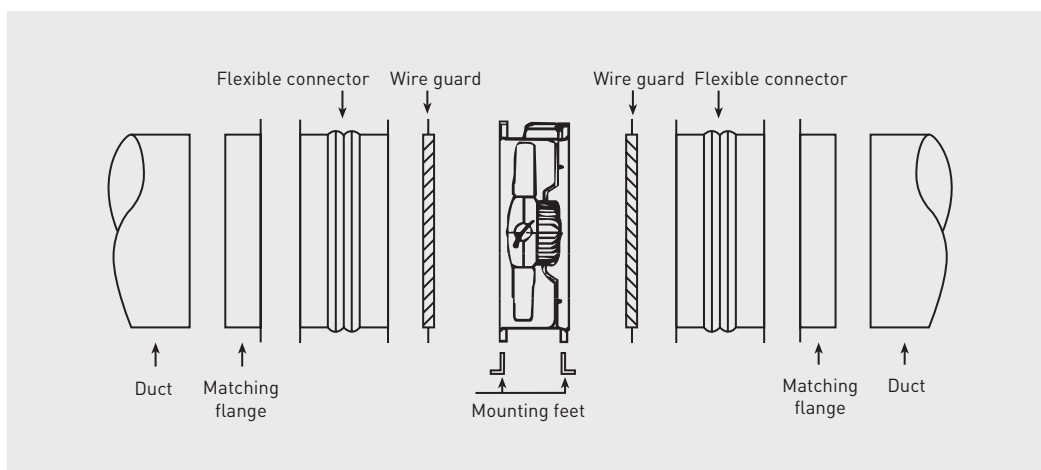
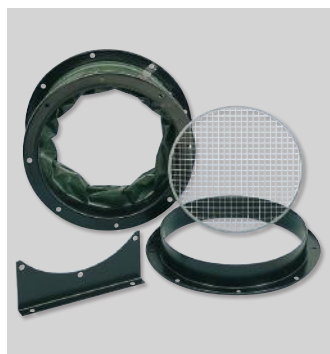

Model	Wire guard		Matching flange	Mounting feet	Bellmouth protection guard	Flexible connector	Flexible connector explosion proof (ATEX)
	Inlet (impeller side)	Outlet (motor side)					
TCBB / TCBT 250	DEF-250 T	DEF-250 T	ARO BRIDA COMPACT-250	PIE-250	-	ACOP.BRIDA-250	ACOPEL EX 250/160 N
TCBB / TCBT 315	DEF-315 T	DEF-315 T	ARO BRIDA COMPACT-315	PIE-315	EMB-315 T	ACOP.BRIDA-315	ACOPEL EX 315/160 N
TCBB / TCBT 355	DEF-355 T	DEF-355 T	ARO BRIDA COMPACT-355	PIE-355	EMB-355 T	ACOP.BRIDA-355	ACOPEL EX 355/160 N
TCBB / TCBT 400	DEF-400 T	DEF-400 T	ARO BRIDA COMPACT-400	PIE-400	EMB-400 T	ACOP.BRIDA-400	ACOPEL EX 400/160 N
TCBB / TCBT 450	DEF-450 T	DEF-450 T	ARO BRIDA COMPACT-450	PIE-450	EMB-450 T	ACOP.BRIDA-450	ACOPEL EX 450/160 N
TCBB / TCBT 500	DEF-500 T	DEF-500 T	ARO BRIDA COMPACT-500	PIE-500	EMB-500 T	ACOP.BRIDA-500	ACOPEL EX 500/160 N
TCBB / TCBT 560	DEF-560 T	DEF-560 T	ARO BRIDA COMPACT-560	PIE-560	EMB-560 T	ACOP.BRIDA-560	ACOPEL EX 560/160 N
TCBB / TCBT 630	DEF-630 T	DEF-630 T	ARO BRIDA COMPACT-630	PIE-630	EMB-630 T	ACOP.BRIDA-630	ACOPEL EX 630/160 N
TCBT 4-710/H	DEF-710 T	DEF-710/H-T DESCARGA	ARO BRIDA COMPACT-710	PIE-710	EMB-710 T	ACOP.BRIDA-710	ACOPEL EX 710/160 N
TCBT 4-710/L	DEF-710 T	DEF-710/L-T DESCARGA	ARO BRIDA COMPACT-710	PIE-710	EMB-710 T	ACOP.BRIDA-710	ACOPEL EX 710/160 N
TCBB / TCBT 6-710	DEF-710 T	DEF-710 T	ARO BRIDA COMPACT-710	PIE-710	EMB-710 T	ACOP.BRIDA-710	ACOPEL EX 710/160 N
TCBT 800	DEF-800 T	DEF.DES.TGT/THGT-800*	ARO BRIDA COMPACT-800	PIE-800	EMB-800 T	ACOP.BRIDA-800	ACOPEL EX 800/160 N

* For more information see Mounting achas cessorries.

ELECTRICAL ACCESSORIES



REB-1N / REB-2,5N
 Single phase electronic speed controllers.



**REB-5
 REB-10**
 Single phase electronic speed controllers.



RMB/RMT
 Single and three phase auto transformer speed controllers.



VFTM TRI IP54
 Adjustable frequency drive for three phase motors from 0,37 to 15 kW, 230V or 400V.



VFKB IP65
 Adjustable frequency drives for three phase motors from 0,37 to 4 kW 230V or 400V.



COM D/S
 To connect three phase fans with 400 V motor. For three phase models.

TCBB/TCBT PERFORMANCE CURVES

- q_v : Airflow in m^3/h and m^3/s .
- p_{sf} : Static pressure in Pa.
- SFP: Specific fan power in $W/m^3/s$.
- P: Input power in W.
- Measurement category: C or D depending on the models.
- Efficiency category: Static or Total depending on the models.
- Fan tested with inlet bellmouth.
- Fan efficiency without speed control.
- Airflow data in accordance with ISO 5801.
- Sound pressure level dB(A), measured in a free field distance equal to 3 times the diameter, with a minimum of 1,5 m.

- MC** Measurement category
- EC** Efficiency category
- VSD** Speed control: supplied with the fan
- SR** Specific ratio
- η [%] Efficiency
- N** Efficiency grade
- [kW]** Absorbed power
- [m³/h]** Airflow
- [Pa]** Static pressure
- [RPM]** Speed

PERFORMANCE CURVES - 2 POLE MOTORS

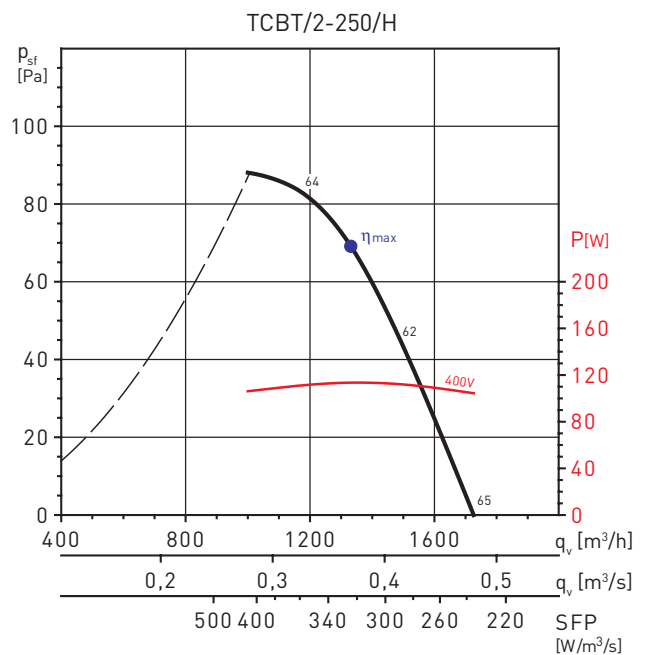
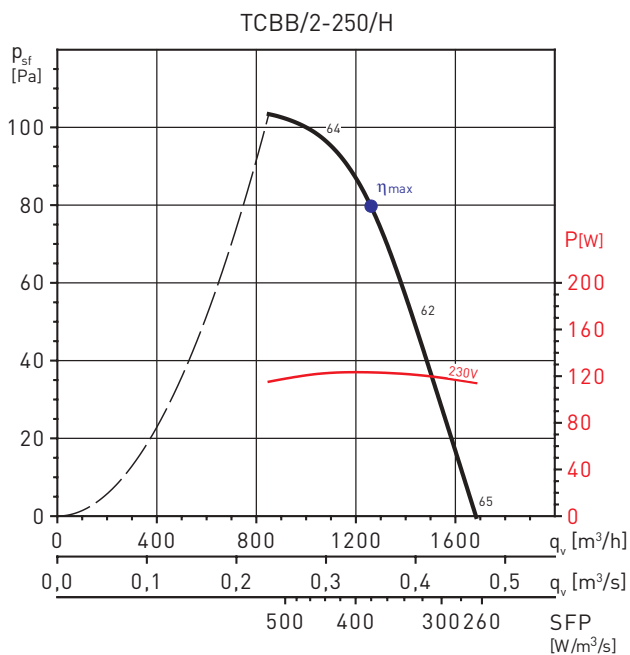

PERFORMANCE CURVES - 4 POLE MOTORS

TCBB/4-250/H

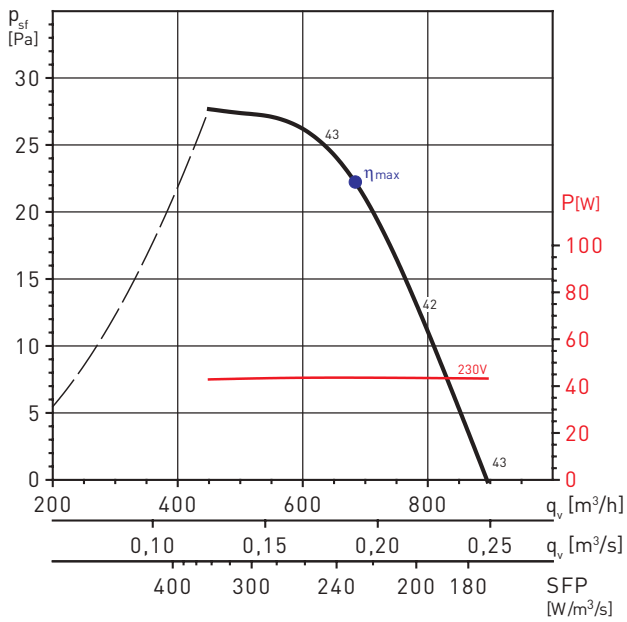

TCBB/4-315/H

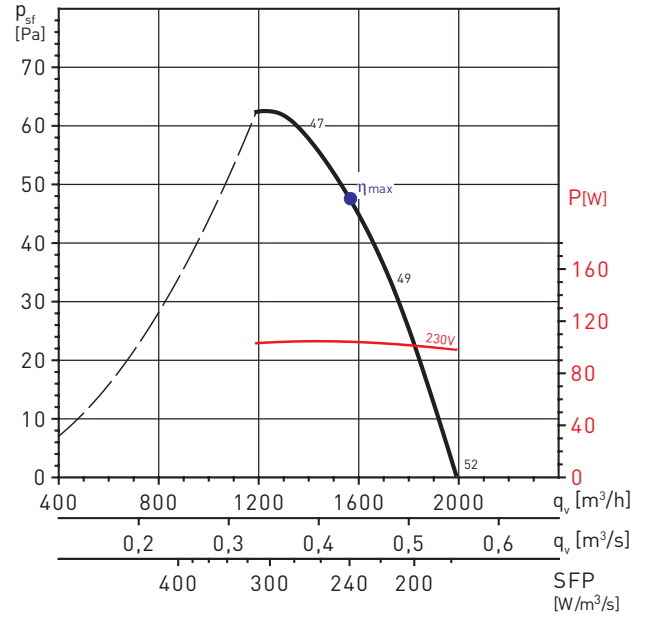

TCBB/4-355/H

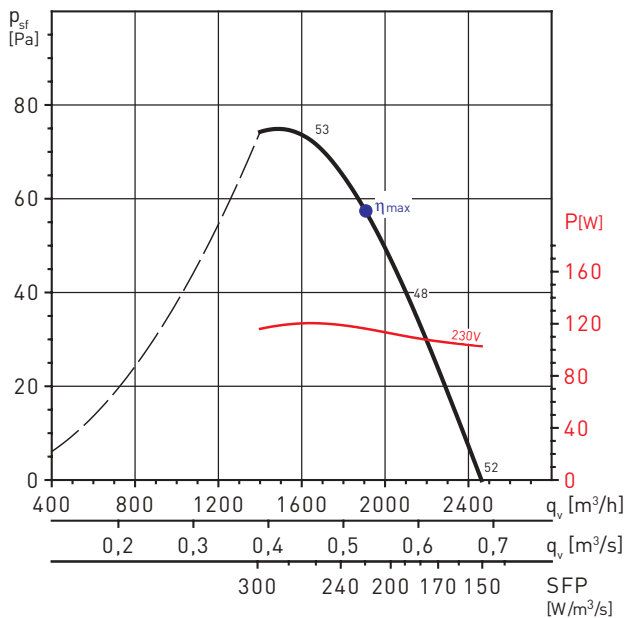

TCBB/4-400/H

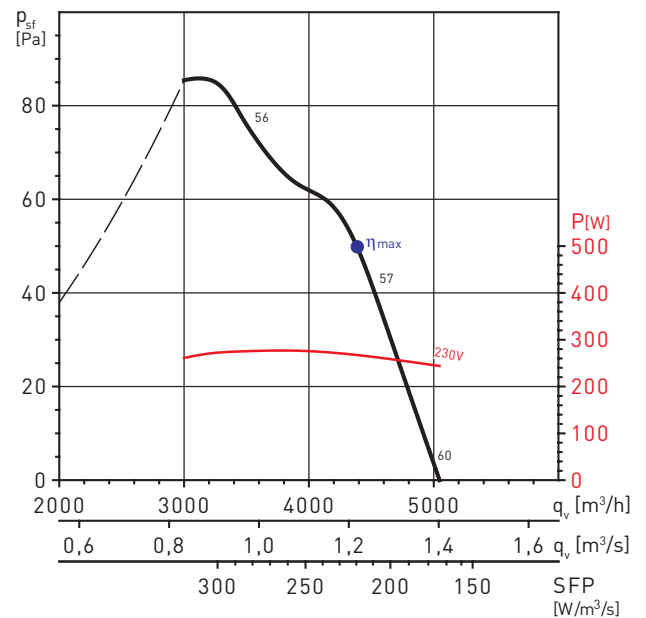

MC	EC	VSD	SR	η [%]	N	[kW]	[m³/h]	[Pa]	[RPM]
D	Total	No	1	48,5	58,4	0,267	4386	106	1397

PERFORMANCE CURVES - 4 POLE MOTORS

TCBB/4-450/H

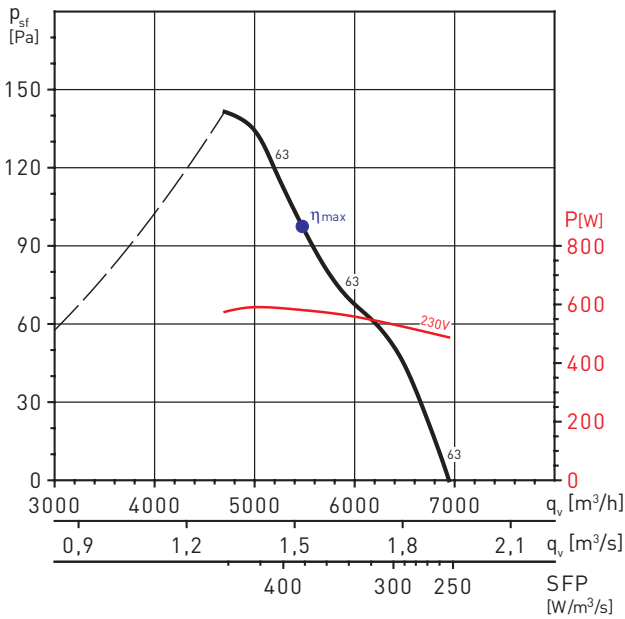

MC	EC	VSD	SR	η [%]	N	[kW]	[m ³ /h]	[Pa]	[RPM]
C	Static	No	1	32,3	40,1	0,582	4783	142	1368

TCBB/4-500/H

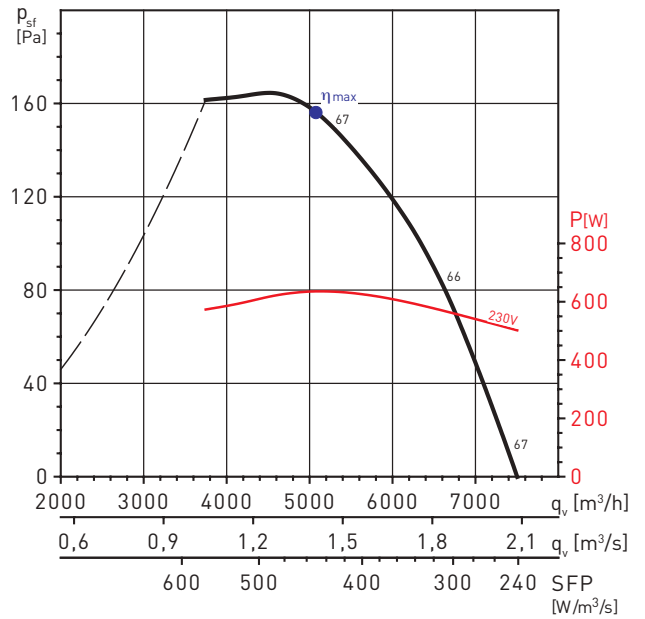

MC	EC	VSD	SR	η [%]	N	[kW]	[m ³ /h]	[Pa]	[RPM]
C	Static	No	1	34,5	42,1	0,636	5075	156	1367

TCBB/4-560/L

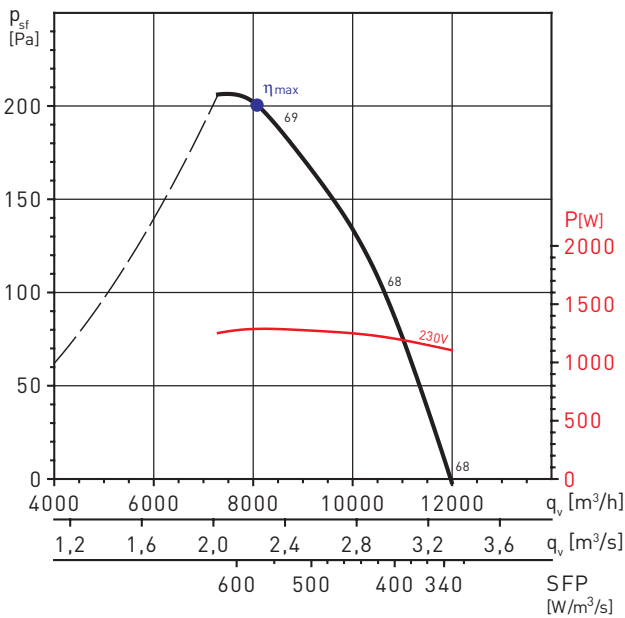

MC	EC	VSD	SR	η [%]	N	[kW]	[m ³ /h]	[Pa]	[RPM]
C	Static	No	1	34,7	40,3	1,288	8071	200	1382

TCBB/4-560/H

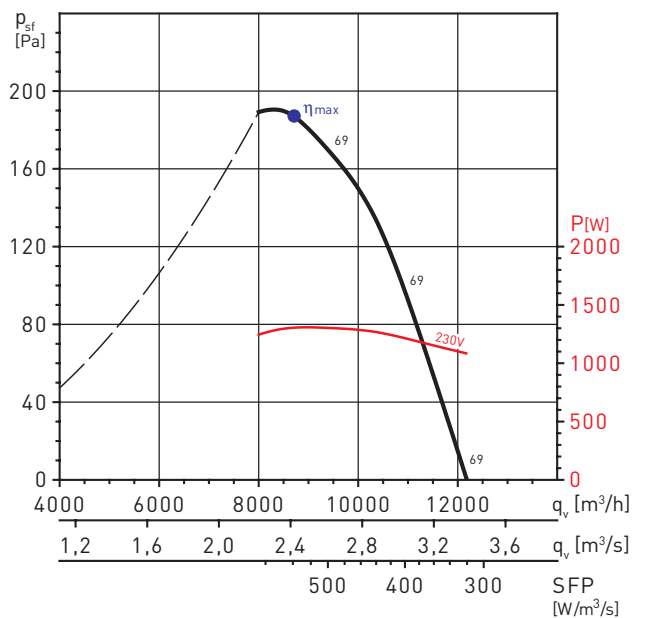

MC	EC	VSD	SR	η [%]	N	[kW]	[m ³ /h]	[Pa]	[RPM]
C	Static	No	1	34,6	40,2	1,305	8700	187	1370

PERFORMANCE CURVES - 4 POLE MOTORS

TCBB/4-630/L

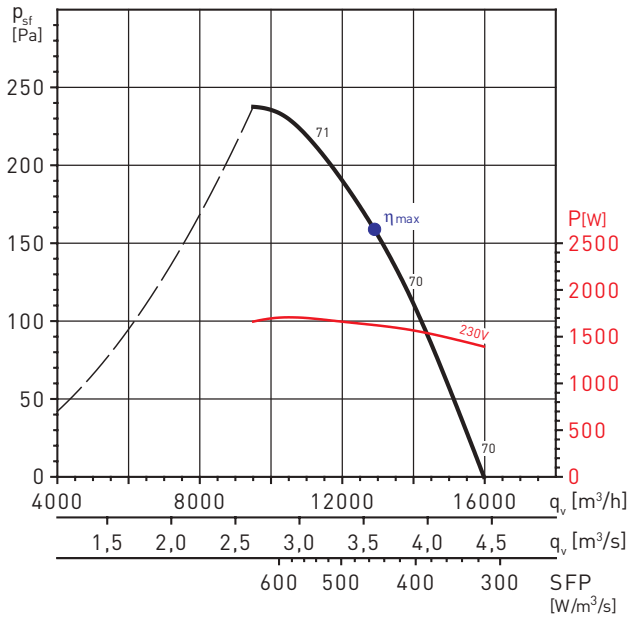

MC	EC	VSD	SR	η [%]	N	[kW]	[m³/h]	[Pa]	[RPM]
D	Total	No	1	53,4	58,4	1,624	12.896	241	1332

TCBT/4-250/H

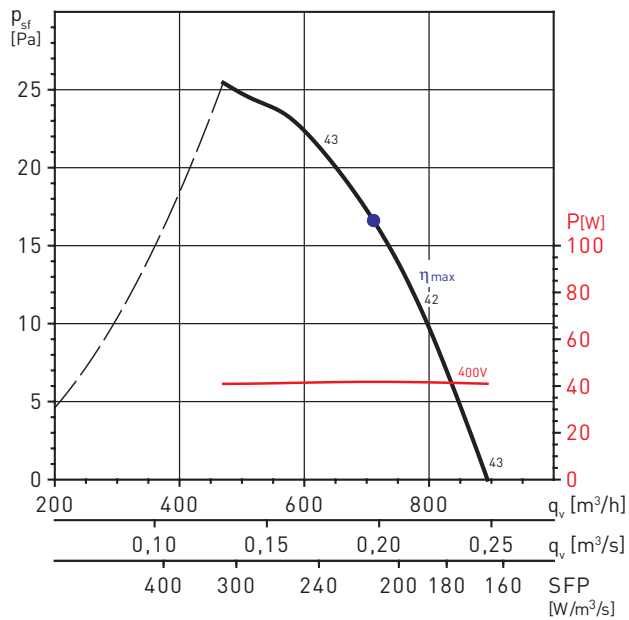

TCBT/4-315/H

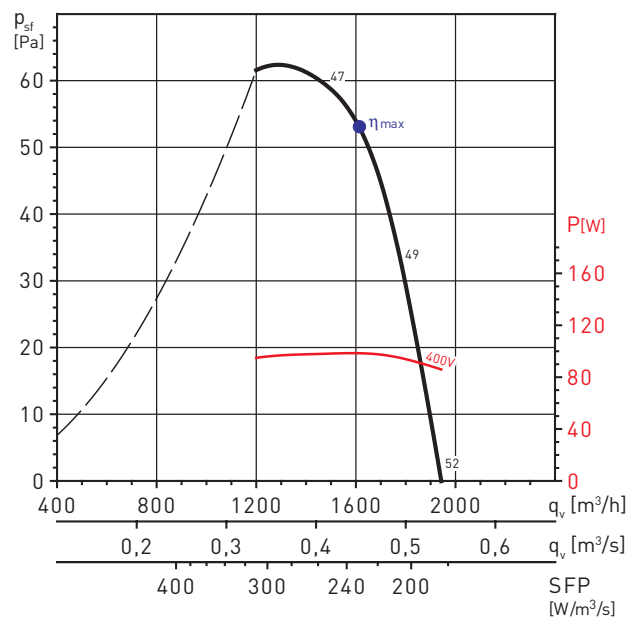

PERFORMANCE CURVES - 4 POLE MOTORS

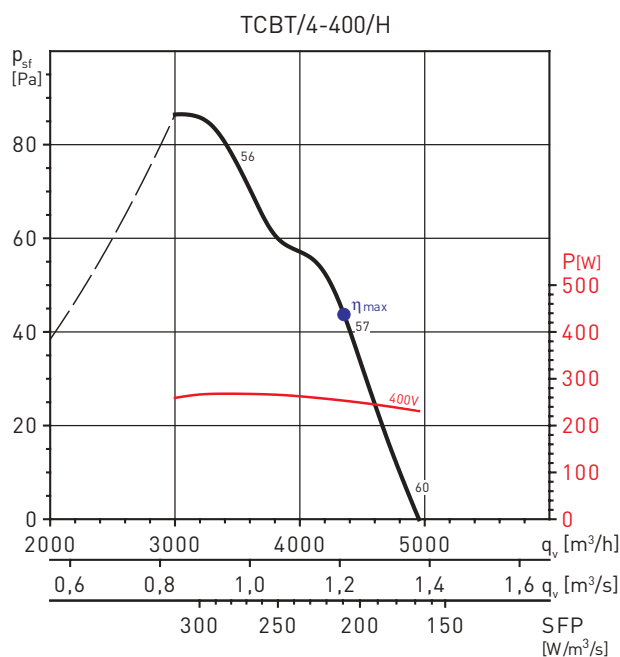
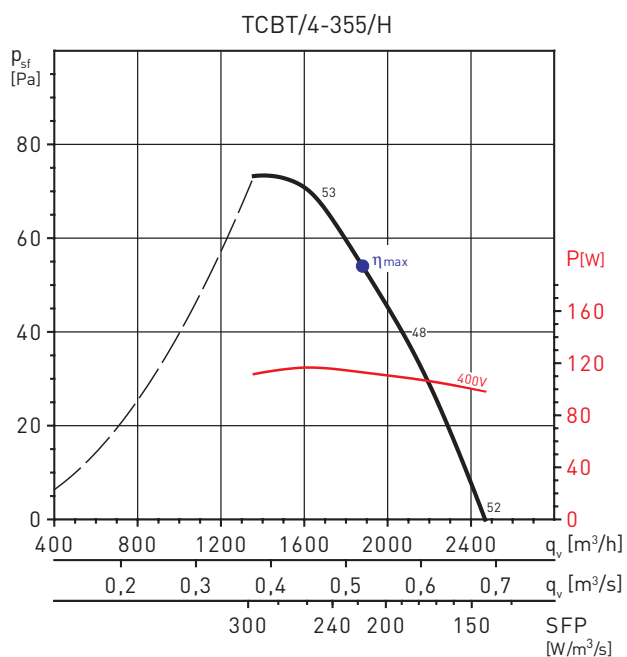

MC	EC	VSD	SR	η [%]	N	[kW]	[m³/h]	[Pa]	[RPM]
D	Total	No	1	47,9	58,0	0,255	4281	103	1391

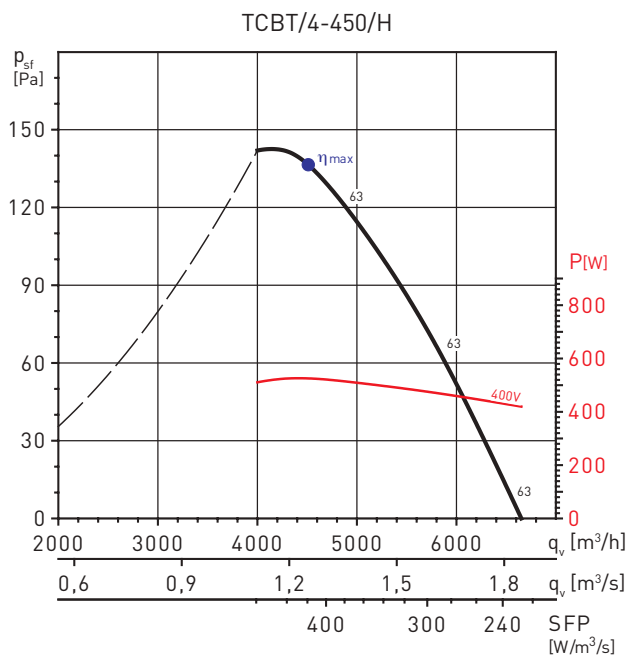

MC	EC	VSD	SR	η [%]	N	[kW]	[m³/h]	[Pa]	[RPM]
C	Static	No	1	32,4	40,5	0,526	4510	136	1374

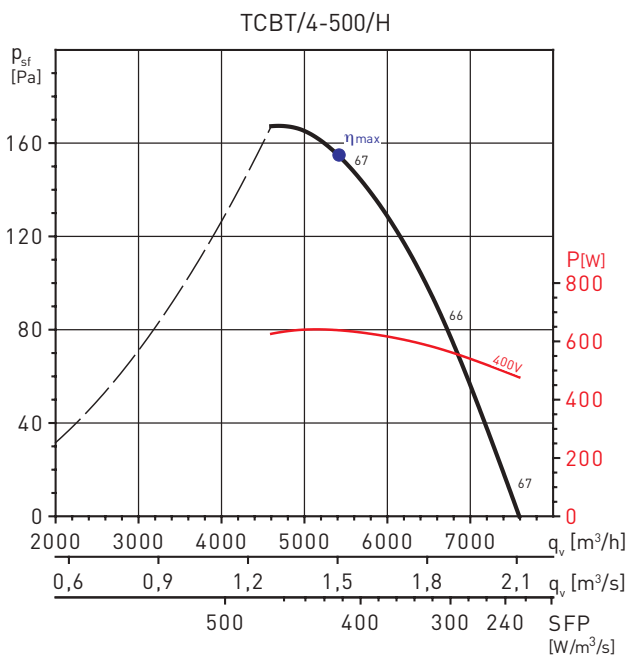

MC	EC	VSD	SR	η [%]	N	[kW]	[m³/h]	[Pa]	[RPM]
C	Static	No	1	36,3	43,9	0,638	5409	155	1381

PERFORMANCE CURVES - 4 POLE MOTORS

TCBT/4-560/L

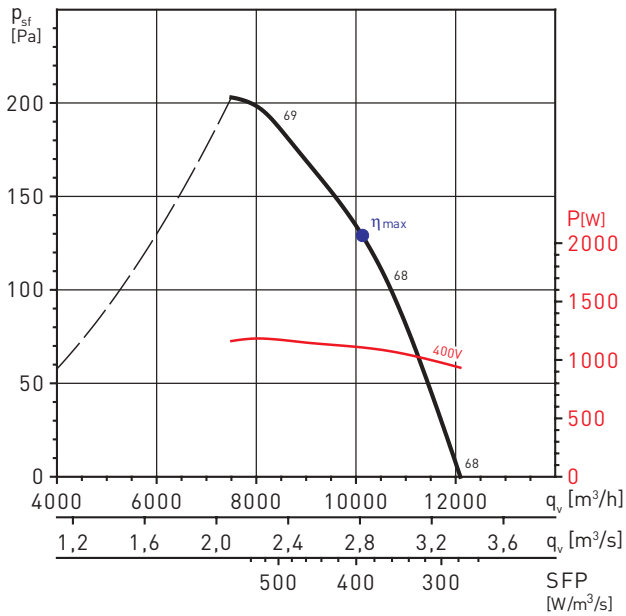

MC	EC	VSD	SR	η [%]	N	[kW]	[m³/h]	[Pa]	[RPM]
D	Total	No	1	53,2	59,3	1,107	10127	208	1390

TCBT/4-560/H

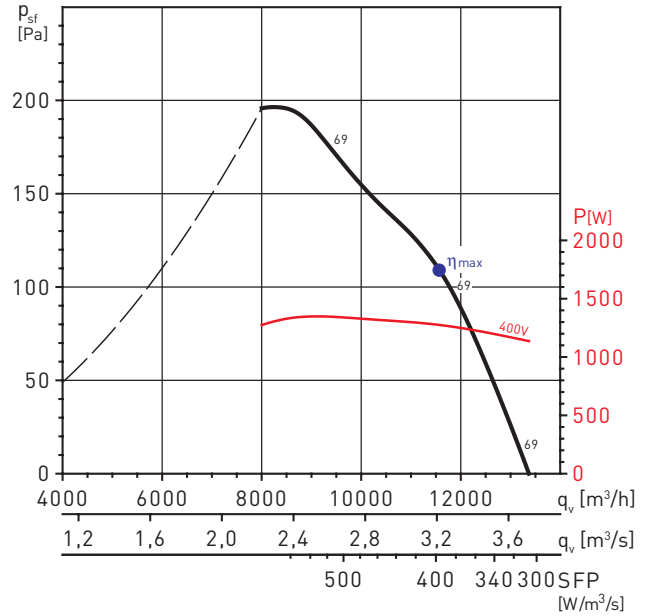

MC	EC	VSD	SR	η [%]	N	[kW]	[m³/h]	[Pa]	[RPM]
D	Total	No	1	53,4	59,1	1,275	11576	212	1372

TCBT/4-630/L

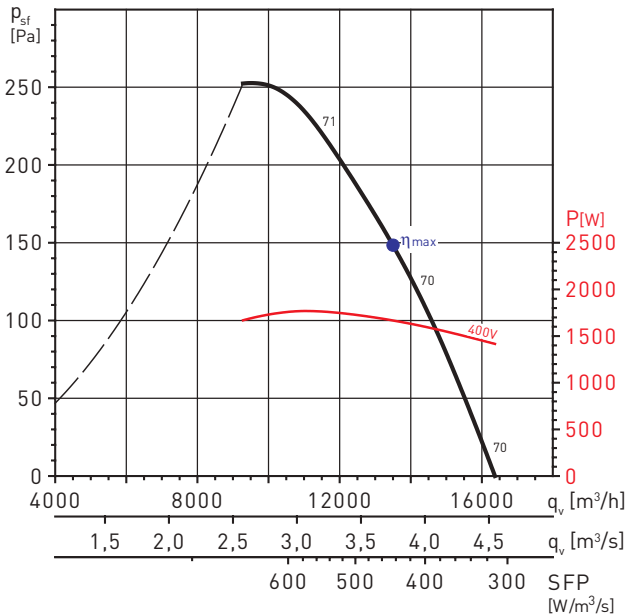

MC	EC	VSD	SR	η [%]	N	[kW]	[m³/h]	[Pa]	[RPM]
D	Total	No	1	53,4	58,3	1,667	13505	236	1390

TCBT/4-630/H

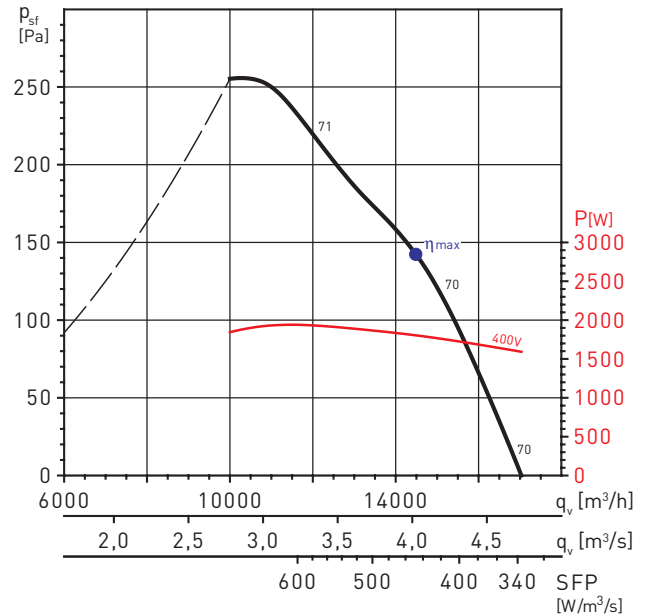

MC	EC	VSD	SR	η [%]	N	[kW]	[m³/h]	[Pa]	[RPM]
D	Total	No	1	54,4	59,1	1,804	14481	244	1383

PERFORMANCE CURVES - 4 POLE MOTORS

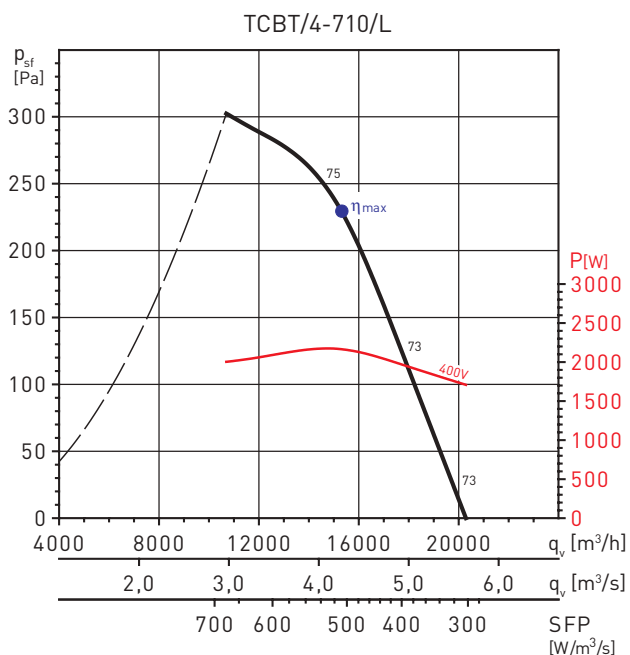

MC	EC	VSD	SR	η [%]	N	[kW]	[m³/h]	[Pa]	[RPM]
D	Total	No	1	58,7	62,9	2,166	15306	299	1414

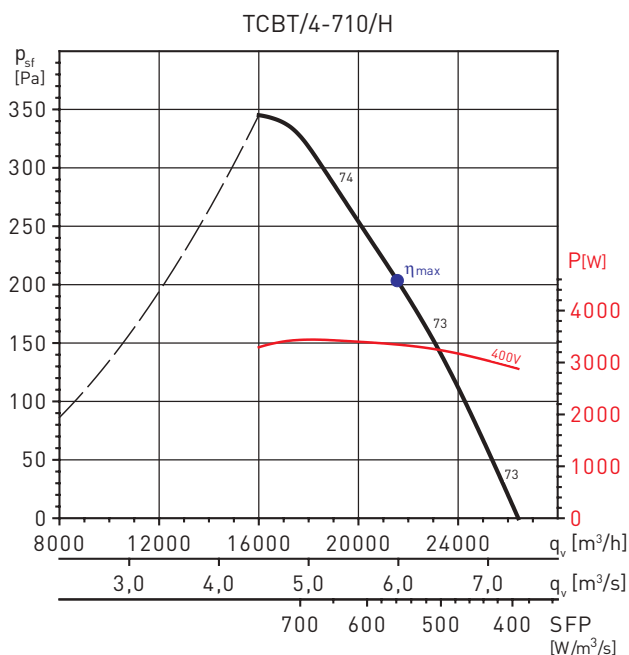

MC	EC	VSD	SR	η [%]	N	[kW]	[m³/h]	[Pa]	[RPM]
D	Total	No	1	61,4	64,4	3,346	21563	341	1451

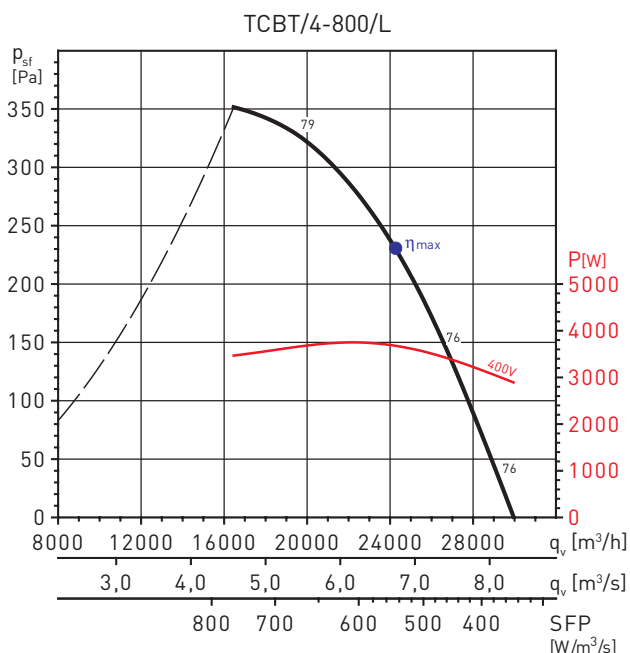

MC	EC	VSD	SR	η [%]	N	[kW]	[m³/h]	[Pa]	[RPM]
D	Total	No	1	62,4	65,2	3,678	24248	339	1445

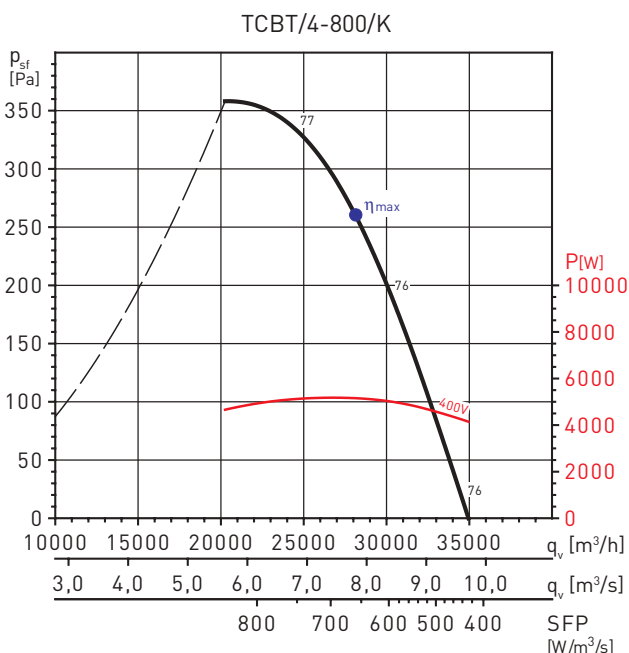

MC	EC	VSD	SR	η [%]	N	[kW]	[m³/h]	[Pa]	[RPM]
D	Total	No	1	61,6	63,4	5,156	28120	406	1445

PERFORMANCE CURVES - 4 POLE MOTORS

TCBT/4-800/G

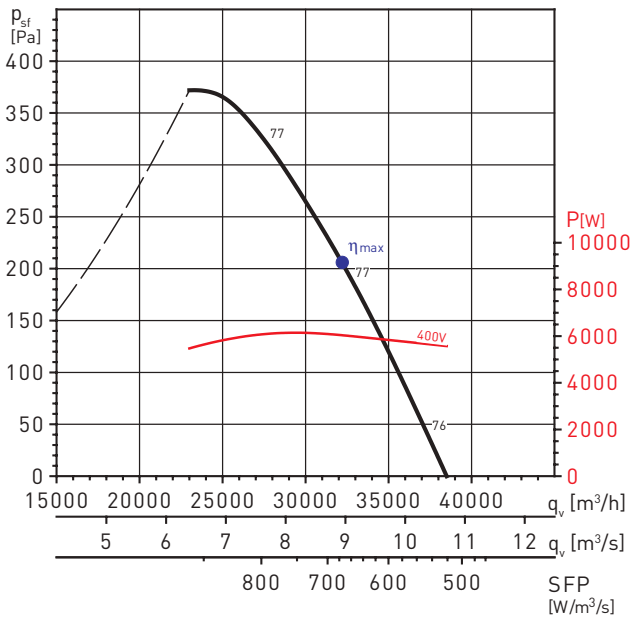

MC	EC	VSD	SR	η [%]	N	[kW]	[m³/h]	[Pa]	[RPM]
D	Total	No	1	58,9	60,3	6,038	32195	397	1460

TCBT/4-800/H

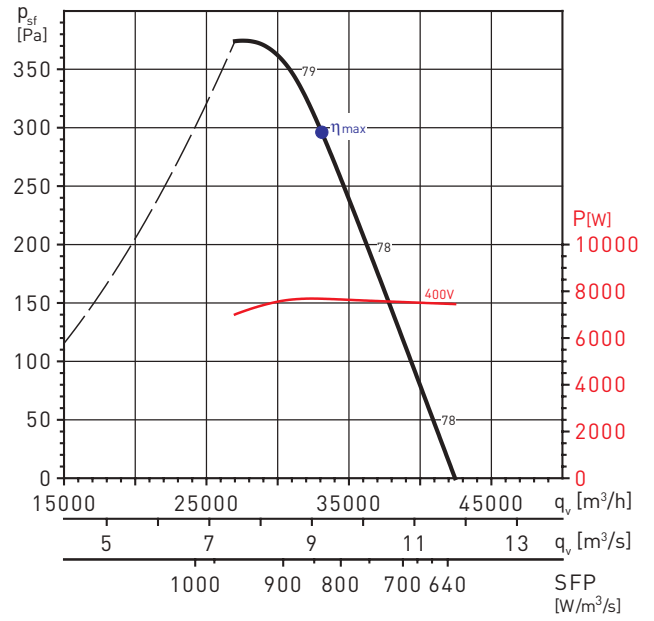

MC	EC	VSD	SR	η [%]	N	[kW]	[m³/h]	[Pa]	[RPM]
D	Total	No	1	59,6	60,3	7,682	33100	498	1468

PERFORMANCE CURVES - 6 POLE MOTORS

TCBB/6-355/H

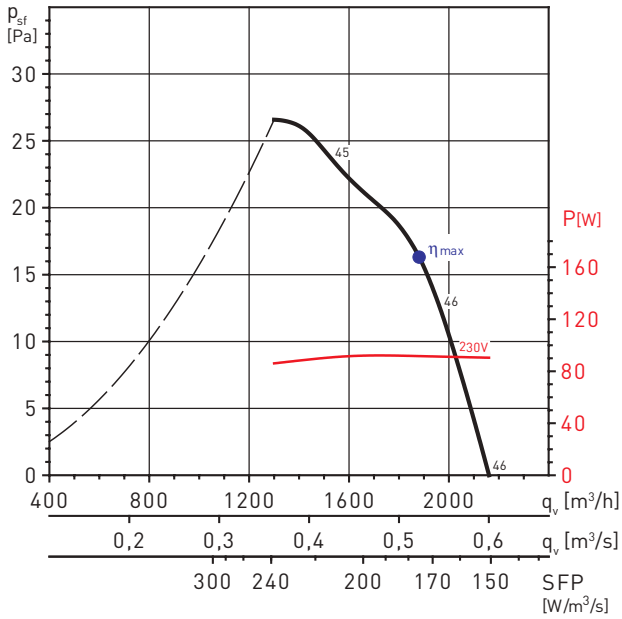

TCBB/6-400/H

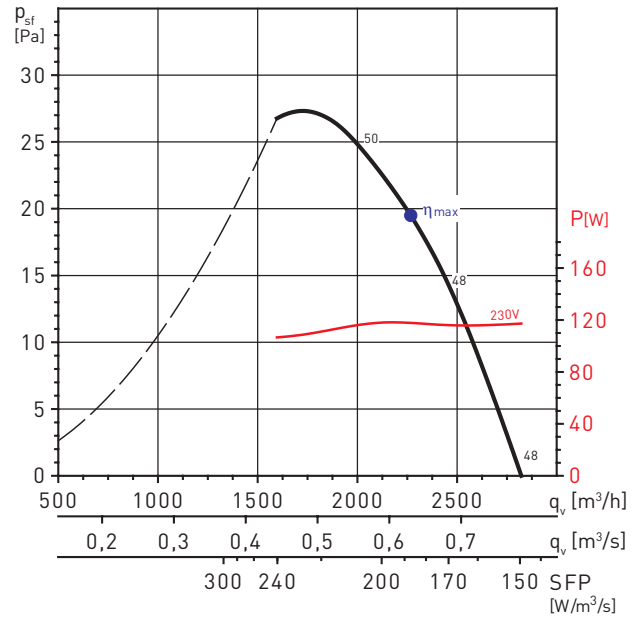

TCBB/6-500/H

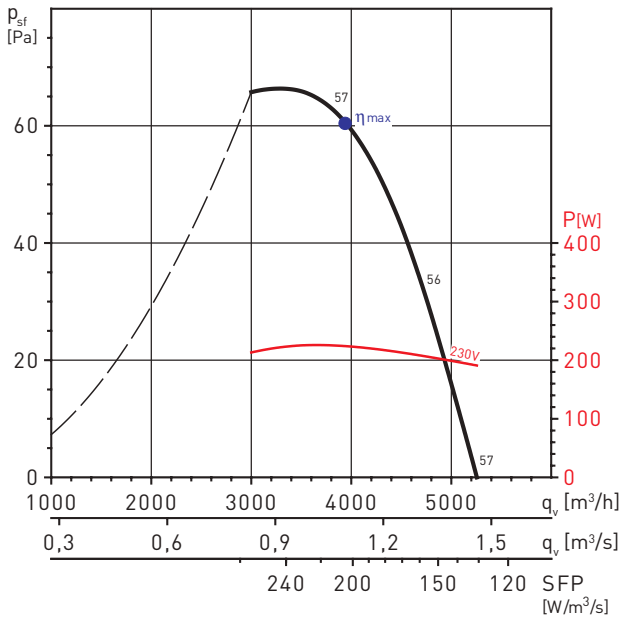

TCBB/6-560/L

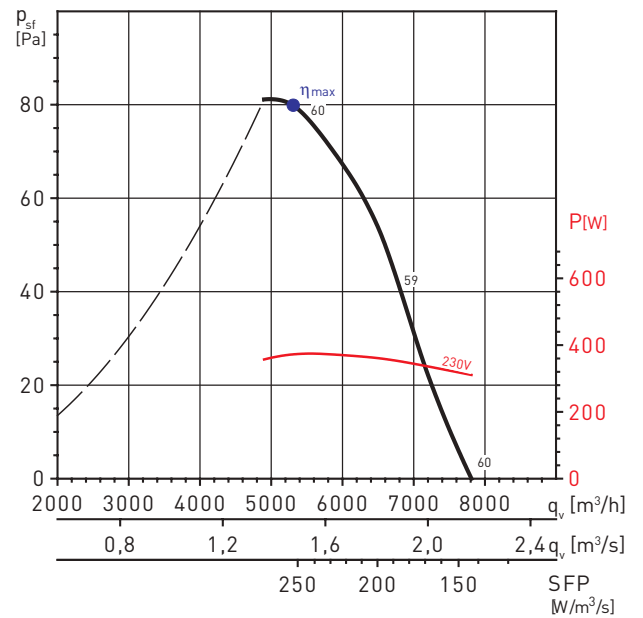

MC	EC	VSD	SR	η [%]	N	[kW]	[m³/h]	[Pa]	[RPM]
C	Static	No	1	29,6	40,0	0,224	3945	61	886

MC	EC	VSD	SR	η [%]	N	[kW]	[m³/h]	[Pa]	[RPM]
C	Static	No	1	31,6	40,6	0,372	5306	80	894

PERFORMANCE CURVES - 6 POLE MOTORS

TCBB/6-630/L

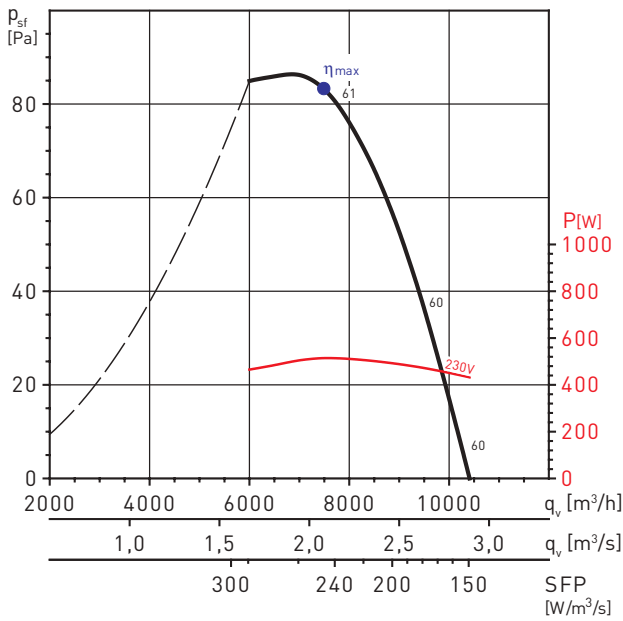

MC	EC	VSD	SR	η[%]	N	[kW]	[m³/h]	[Pa]	[RPM]
C	Static	No	1	33,7	41,9	0,514	7499	83	889

TCBB/6-710/L

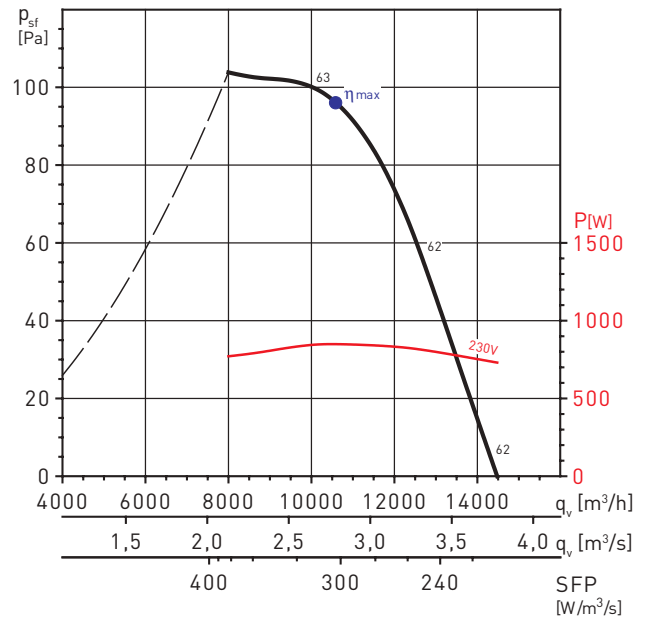

MC	EC	VSD	SR	η[%]	N	[kW]	[m³/h]	[Pa]	[RPM]
C	Static	No	1	33,3	40,1	0,849	10587	96	901

TCBT/6-355/H

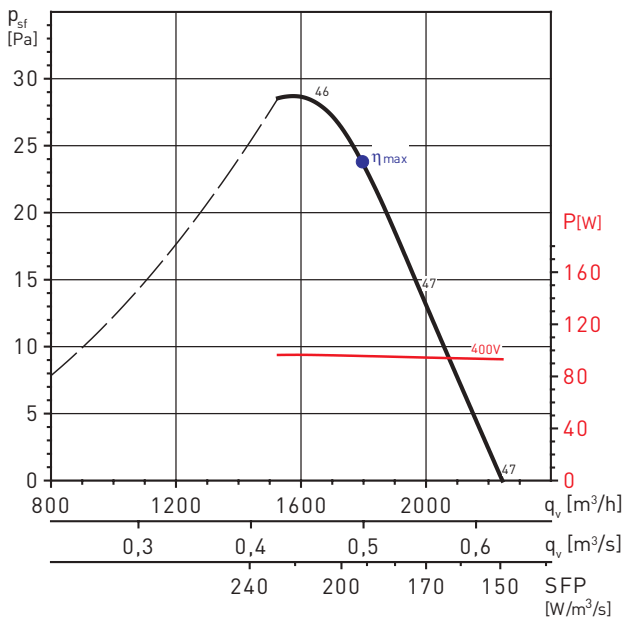

TCBT/6-400/H

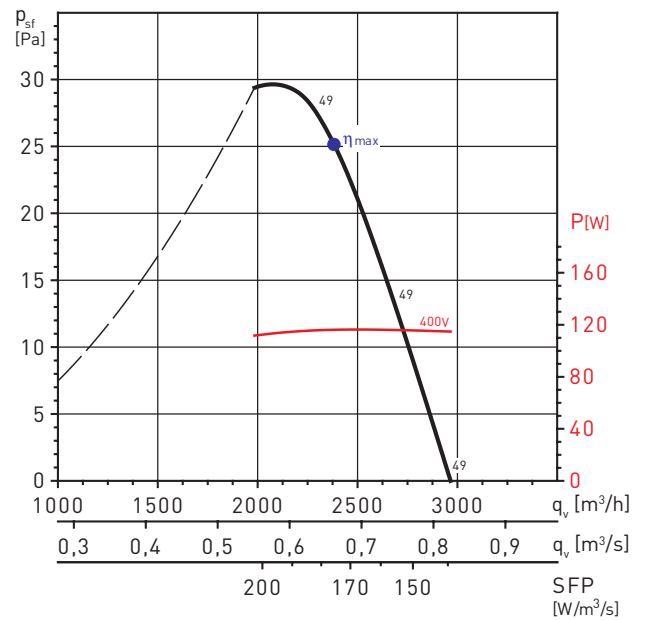

PERFORMANCE CURVES - 6 POLE MOTORS

TCBT/6-450/H

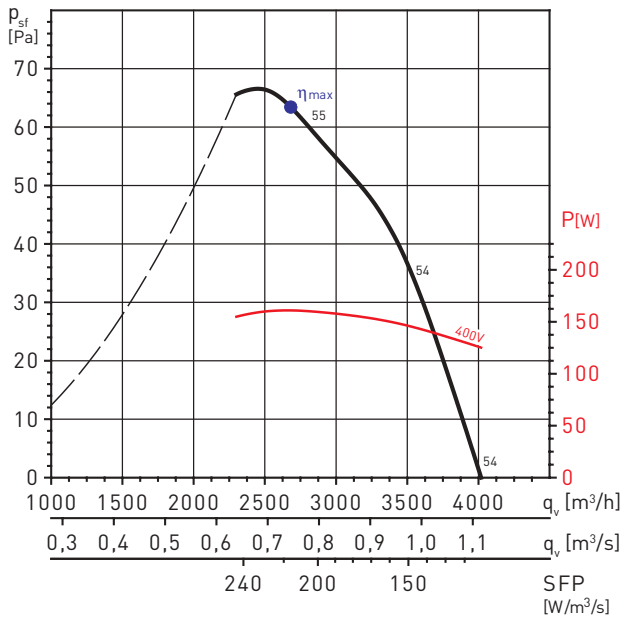

MC	EC	VSD	SR	η [%]	N	[kW]	[m ³ /h]	[Pa]	[RPM]
C	Static	No	1	29,1	40,4	0,161	2684	63	911

TCBT/6-500/H

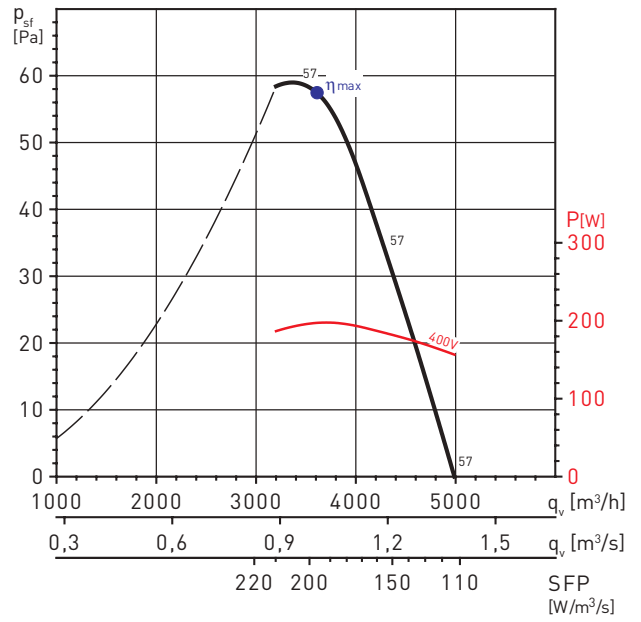

MC	EC	VSD	SR	η [%]	N	[kW]	[m ³ /h]	[Pa]	[RPM]
C	Static	No	1	29,2	40,0	0,197	3608	58	899

TCBT/6-560/H

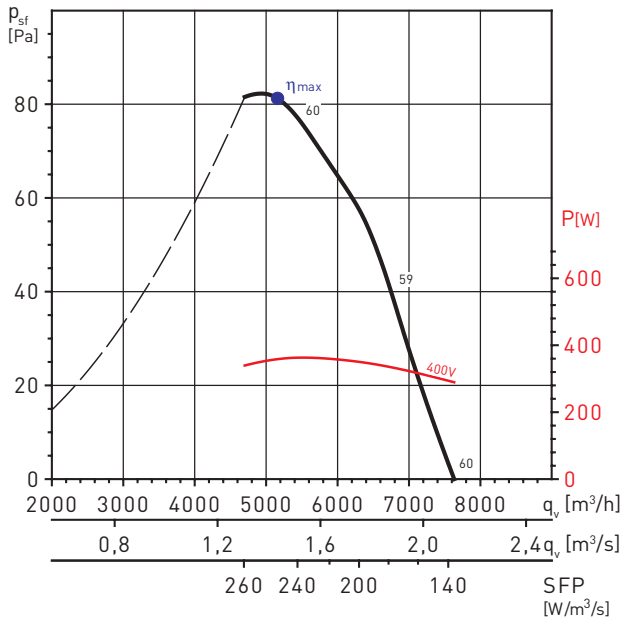

MC	EC	VSD	SR	η [%]	N	[kW]	[m ³ /h]	[Pa]	[RPM]
C	Static	No	1	32,5	41,6	0,359	5164	81	895

TCBT/6-630/L

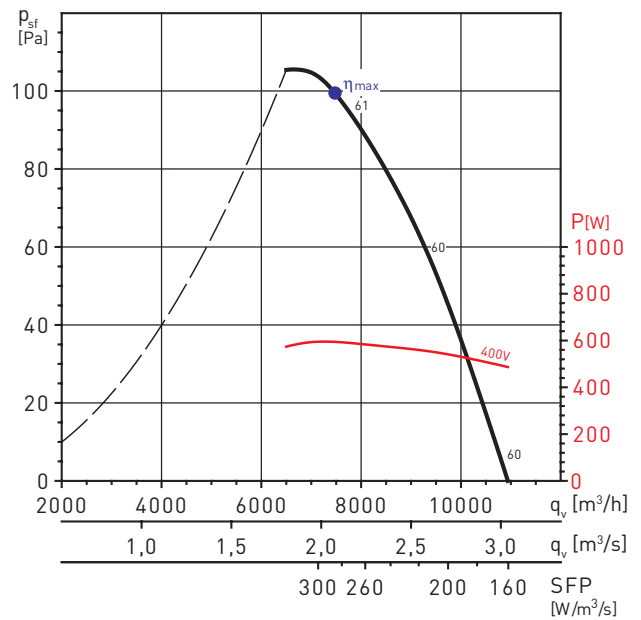

MC	EC	VSD	SR	η [%]	N	[kW]	[m ³ /h]	[Pa]	[RPM]
C	Static	No	1	34,6	42,4	0,594	7481	99	888

PERFORMANCE CURVES - 6 POLE MOTORS

TCBT/6-630/H

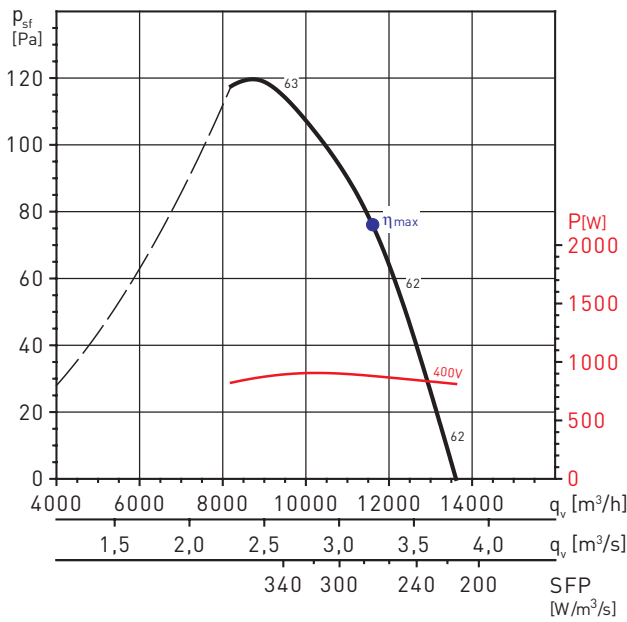

MC	EC	VSD	SR	η [%]	N	[kW]	[m ³ /h]	[Pa]	[RPM]
D	Total	No	1	51,7	58,4	0,880	11606	141	949

TCBT/6-710/L

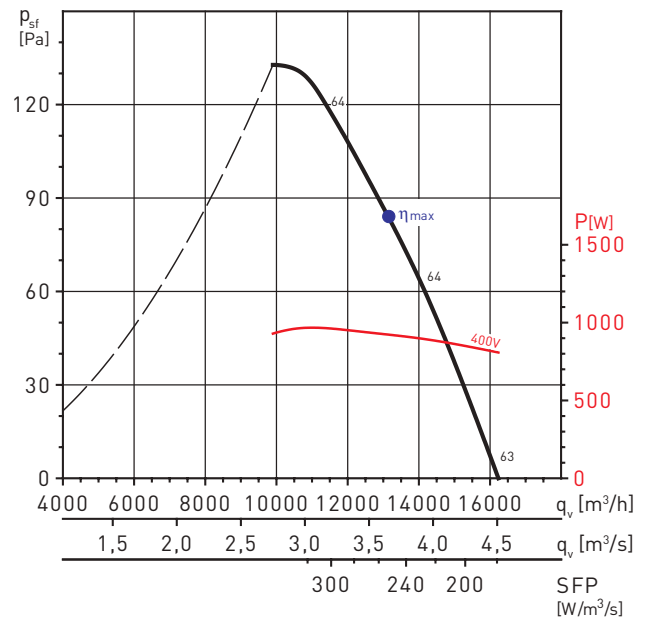

MC	EC	VSD	SR	η [%]	N	[kW]	[m ³ /h]	[Pa]	[RPM]
D	Total	No	1	53,7	60,3	0,921	13209	134	894

TCBT/6-710/H

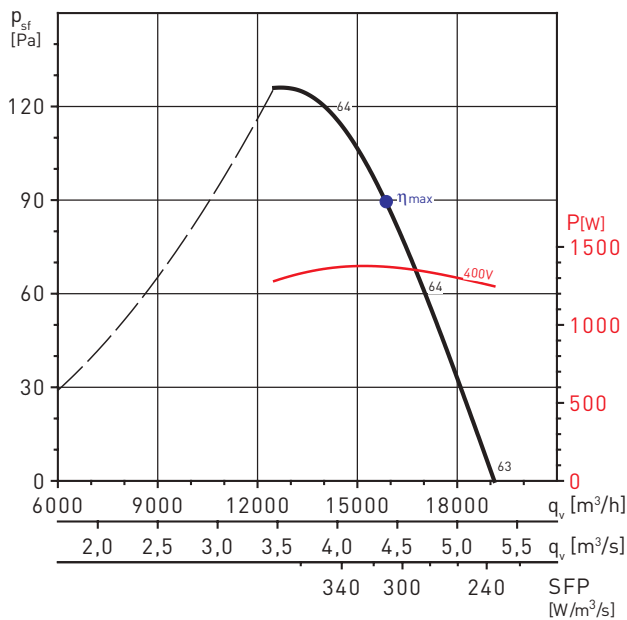

MC	EC	VSD	SR	η [%]	N	[kW]	[m ³ /h]	[Pa]	[RPM]
D	Total	No	1	52,7	58,2	1,376	15643	167	897

TCBT/6-800/L

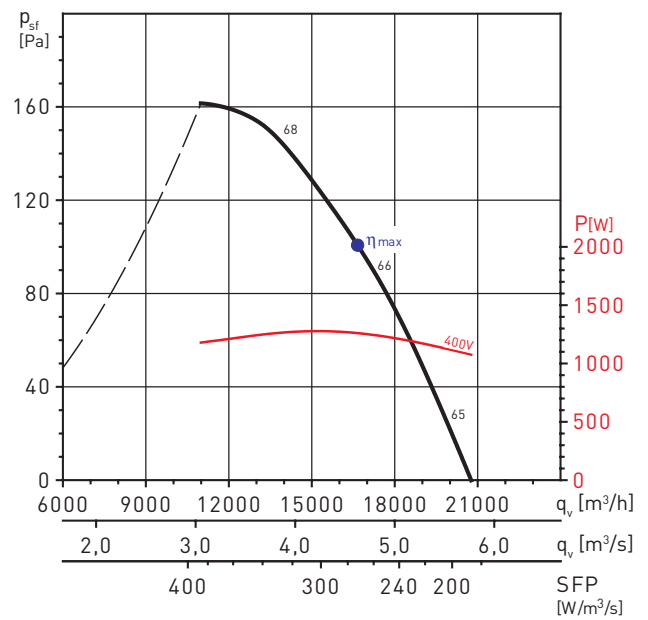

MC	EC	VSD	SR	η [%]	N	[kW]	[m ³ /h]	[Pa]	[RPM]
D	Total	No	1	56,0	61,7	1,260	16668	152	955

PERFORMANCE CURVES - 6 POLE MOTORS

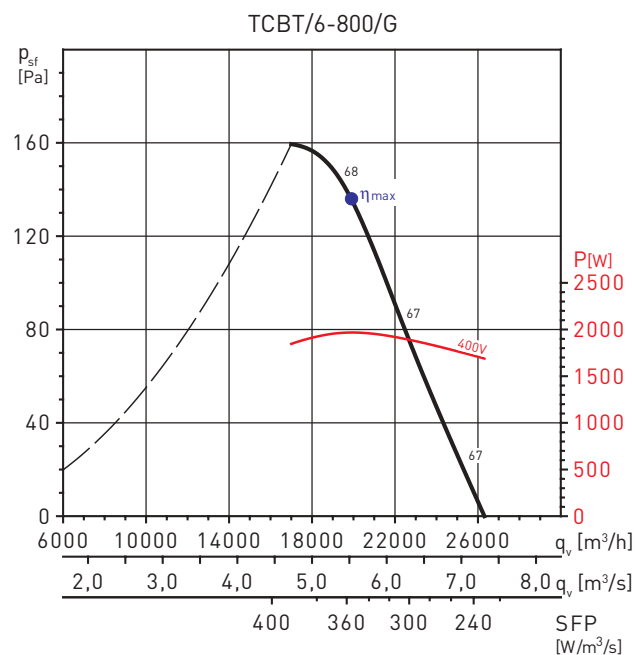
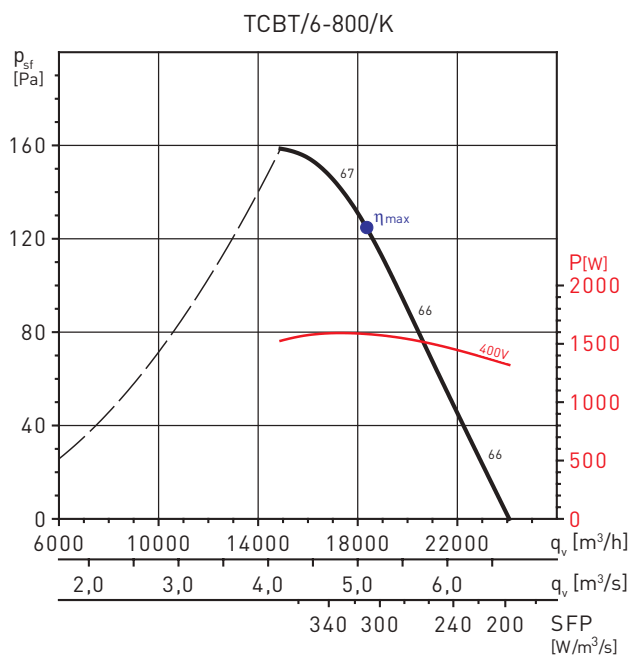

MC	EC	VSD	SR	η [%]	N	[kW]	[m³/h]	[Pa]	[RPM]
D	Total	No	1	60,1	65,2	1,584	18352	187	965

MC	EC	VSD	SR	η [%]	N	[kW]	[m³/h]	[Pa]	[RPM]
D	Total	No	1	58,6	63,1	1,968	19904	209	971

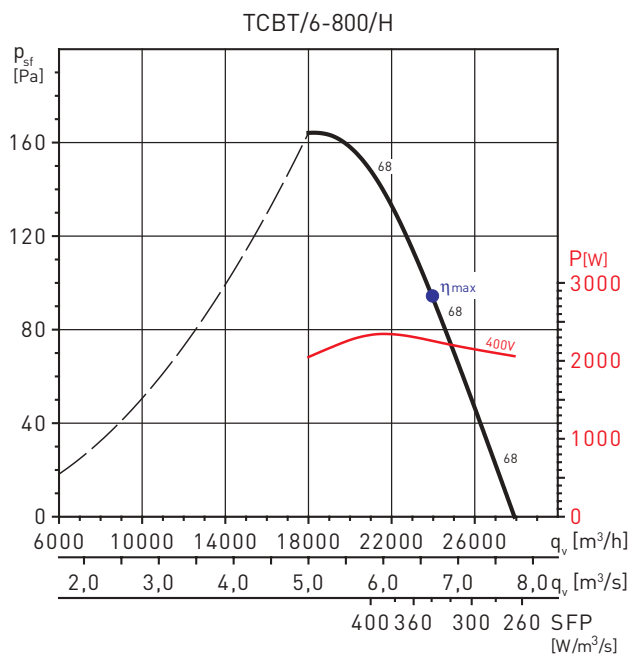

MC	EC	VSD	SR	η [%]	N	[kW]	[m³/h]	[Pa]	[RPM]
D	Total	No	1	59,0	63,1	2,257	23956	200	962